

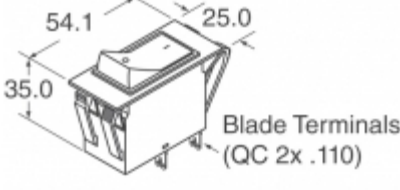

3120-F321-P7T1-W02K-4A



Obrázky jsou pouze orientační.
Podrobné informace o produktu naleznete v části Technické údaje produktu.

Koupit 3120-F321-P7T1-W02K-4A s důvěrou od Component-World.HK, 1 rok záruka



Part Number: 3120-F321-P7T1-W02K-4A
Výrobce: E-T-A
Popis: CIR BRKR THRM 4A 250VAC 50VDC
Datový list:  [3120-F Series Datasheet](#)

RoHS Status: Bez olova / V souladu RoHS
Ship From: Hong Kong
Shipment Way: DHL/Fedex/TNT/UPS/EMS

[Request For Quotation](#)











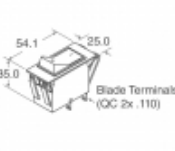
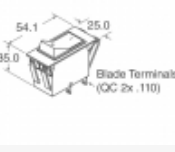

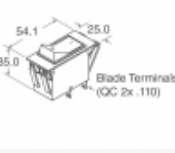
PARAMETR PRODUKTU

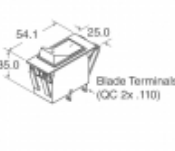
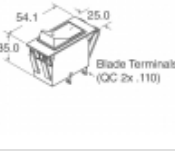
Part Number	3120-F321-P7T1-W02K-4A	Výrobce	E-T-A
Popis	CIR BRKR THRM 4A 250VAC 50VDC	Stav volného vedení / RoHS	Bez olova / V souladu RoHS
Dostupné množství	2591 pcs	Datový list	3120-F Series Datasheet
Kategorie	Ochrana obvodu	Napítí - DC	50V
Napítí - AC	250V	Série	3120-F
Počet pólů	2	Typ montáže	Panel Mount
Úroveň citlivosti na vlhkost (MSL)	1 (Unlimited)	Výrobní standardní doba výroby	9 Weeks
Stav volného vedení / RoHS	Lead free / RoHS Compliant	Osvětlení napětí (nominální)	-
Osvětlení	-	Jmenovitá hodnota proudu	4A
Breaker Typ	Thermal	Pohon Type	Rocker

Component-World.com je spolehlivý distributor elektronických součástek. Specializujeme se na všechny elektronické komponenty řady E-T-A. Máme 2591 kusy E-T-A 3120-F321-P7T1-W02K-4A na skladě dostupných. Vyžádejte si citát z distributora součástí elektroniky na Component-World.com, náš prodejní tým vás bude kontaktovat do 24 hodin.

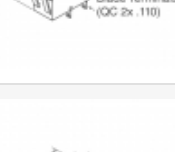
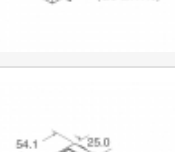
RFQ Email: info@Components-World.com

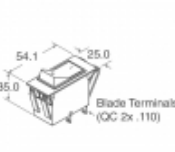
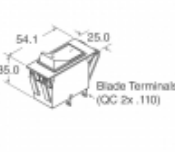
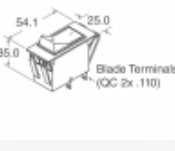
SOUVISEJÍCÍ PRODUKTY

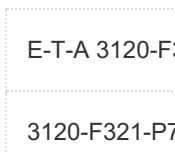
	Část#: 3120-F321-P7T1-W02F-1A Popis: CIR BRKR THRM 1A 250VAC 50VDC	Výrobci: E-T-A	Dotaz
	Část#: 3120-F321-P7T1-W02K-X3120-M2P7M-120V-20A Popis: CIR BRKR THRM 20A 250VAC 50VDC	Výrobci: E-T-A	Dotaz
	Část#: 3120-F321-P7T1-W02D-8A Popis: CIR BRKR THRM 8A 250VAC 50VDC	Výrobci: E-T-A	Dotaz
	Část#: 3120-F321-P7T1-W02F-5A Popis: CIR BRKR THRM 5A 250VAC 50VDC	Výrobci: E-T-A	Dotaz
	Část#: 3120-F321-P7T1-W02K-X3120-M2P7M-120V-16A Popis: CIRC BRKR THRM	Výrobci: E-T-A	Dotaz
	Část#: 3120-F321-P7T1-W02K-8A Popis: CIR BRKR THRM 8A 250VAC 50VDC	Výrobci: E-T-A	Dotaz
	Část#: 3120-F321-P7T1-W02L-12A Popis: CIR BRKR THRM 12A 250VAC 50VDC	Výrobci: E-T-A	Dotaz
	Část#: 3120-F321-P7T1-W02F-2A Popis: CIR BRKR THRM 2A 250VAC 50VDC	Výrobci: E-T-A	Dotaz
	Část#: 3120-F321-P7T1-W02K-0.2A Popis: CIR BRKR THRM 200MA 250VAC 50VDC	Výrobci: E-T-A	Dotaz
	Část#: 3120-F321-P7T1-W02Q-10A Popis: CIR BRKR THRM 10A 250VAC 50VDC	Výrobci: E-T-A	Dotaz
	Část#: 3120-F321-P7T1-W02K-10A Popis: CIR BRKR THRM 10A 250VAC 50VDC	Výrobci: E-T-A	Dotaz
	Část#: 3120-F321-P7T1-W02F-1.2A Popis: CIR BRKR THRM 1.2A 250VAC 50VDC	Výrobci: E-T-A	Dotaz
	Část#: 3120-F321-P7T1-W02L-10A Popis: CIR BRKR THRM 10A 250VAC 50VDC	Výrobci: E-T-A	Dotaz
	Část#: 3120-F321-P7T1-W02D-9A Popis: CIR BRKR THRM 9A 250VAC 50VDC	Výrobci: E-T-A	Dotaz
	Část#: 3120-F321-P7T1-W02F-3A Popis: CIR BRKR THRM 3A 250VAC 50VDC	Výrobci: E-T-A	Dotaz
	Část#: 3120-F321-P7T1-W02K-0.5A Popis: CIR BRKR THRM 500MA 250VAC 50VDC	Výrobci: E-T-A	Dotaz
	Část#: 3120-F321-P7T1-W02K-6A Popis: CIR BRKR THRM 6A 250VAC 50VDC	Výrobci: E-T-A	Dotaz
	Část#: 3120-F321-P7T1-W02L-7A Popis: CIR BRKR THRM 7A 250VAC 50VDC	Výrobci: E-T-A	Dotaz
	Část#: 3120-F321-P7T1-W02L-4A Popis: CIR BRKR THRM 4A 250VAC 50VDC	Výrobci: E-T-A	Dotaz
	Část#: 3120-F321-P7T1-W02Q-1.2A Popis: CIR BRKR THRM 1.2A 250VAC 50VDC	Výrobci: E-T-A	Dotaz

Související klíčová slova pro 3120-F321-P7T1-W02K-4A

E-T-A 3120-F321-P7T1-W02K-4A.	3120-F321-P7T1-W02K-4A distributor	3120-F321-P7T1-W02K-4A dodavatel	3120-F321-P7T1-W02K-4A Cena
3120-F321-P7T1-W02K-4A Stáhnout datasheet.	3120-F321-P7T1-W02K-4A Datasheet.	3120-F321-P7T1-W02K-4A Stock.	koupit 3120-F321-P7T1-W02K-4A.
E-T-A 3120-F321-P7T1-W02K-4A.			